

MOVING YOU FURTHER

# HX520 L

With Tier 4 final / Stage IV Engine installed



\*Photo may include optional equipment.

**Net Power**

SAE J1349 / 316 kW (424 HP) at 1,900 rpm

**Gross Power**

SAE J1995 / 331 kW (444 HP) at 1,900 rpm

**Travel Speed**

5.3 km/hr (3.29 mph) / 3.3 km/hr (2.05 mph)

**Operating Weight**

52,400 kg / 115,520 lb





# RULE THE GROUND

The HX Series excavators are products of HHI's spirit of initiative, creativity and strong drive. HHI's engineers, who are the best in the industry, have worked tirelessly to offer a zero-defect product. The new HX Series reflects customers' needs in the field gleaned by thorough monitoring. They maximize fuel efficiency and performance proven by rigorous field tests and quality control.







\*Photo may include optional equipment.



# RULE THE GROUND

The HX series exceeds customers' expectation!  
Become a true leader on the ground with HHI's HX series.

---



## WORK MAX, WORTH MAX

- ECO Gauge
- IPC (Intelligent Power Control)
- New Variable Power Control
- Attachment Flow Control (Option)
- New Cooling System with Increased Air Flow
- Enlarged Air Inlet with Grill Cover
- Cycle Time Improvement
- Boom Floating Control (Option)



## MORE RELIABLE, MORE SUSTAINABLE

- Durable Cooling Module
- Reinforced Pin, Bush and Polymer Shim
- Reinforced Durability of Upper and Lower Structure and Attachments
- Wear Resistant Cover Plate
- Hi-grade (High-pressure) Hoses



## INFOTAINMENT FRONTIER

- Intelligent and Wide Cluster
- Haptic Control
- Wi-Fi Direct with Smart Phone (Miracast)
- Proportional Auxiliary Hydraulic System
- New Audio System
- New Air Conditioning System



# HX520 L



## MODERN COMFORT, SIMPLE AND SAFE SOLUTION

- AAVM (Advanced Around View Monitoring) Camera System (Option)
- Easy Access to DEF/AdBlue® Supply System
- Hi MATE (Remote Management System)
- Cab Suspension Mount



\*Photo may include optional equipment.

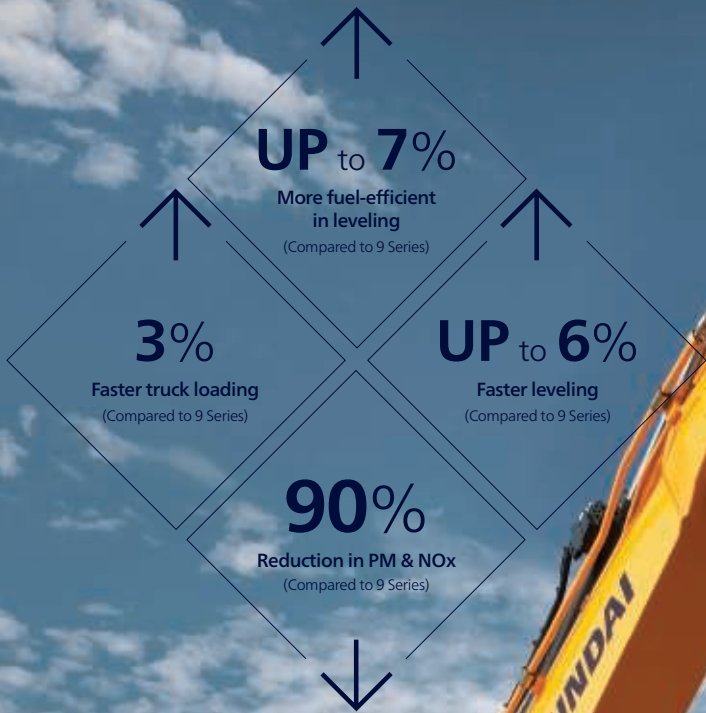

**Fuel Rate Information**

<p>11:18 37°C</p> <p>HYUNDAI</p> <p>Fuel Rate Information</p> <ul style="list-style-type: none"> <li>General Record</li> <li>Hourly Record</li> <li>Daily Record</li> <li>Mode Record</li> </ul>		<p>11:26 37°C</p> <p>HYUNDAI</p> <p>General Record</p> <table border="1"> <tr> <td>Average Fuel Rate</td> <td>A Day Fuel Used</td> </tr> <tr> <td>25.7 ℓ/h</td> <td>233.4 ℓ</td> </tr> <tr> <td>Reset</td> <td>Reset</td> </tr> </table>		Average Fuel Rate	A Day Fuel Used	25.7 ℓ/h	233.4 ℓ	Reset	Reset
Average Fuel Rate	A Day Fuel Used								
25.7 ℓ/h	233.4 ℓ								
Reset	Reset								

\*Photo may include optional equipment.

**Cycle Time Improvement**

The HX Series provides higher productivity on the site by faster operation: it loads trucks up to 3% faster and levels up to 6% faster than the 9 Series.



# WORK MAX, WORTH MAX

## Fuel Efficient System, Allows Great Performance

The HX Series has an eco-friendly, high-performance engine which ensures both excellent fuel efficiency and high power. With outstanding operating performance proven by rigorous tests at various work sites, it will satisfy any customer's needs.



### ECO Gauge

ECO Gauge enable economic operation of machines. The gauge level and color displays engine torque and fuel efficiency level. On top of that, the status of fuel consumption such as average rate and the total amount of fuel consumed are displayed. Hourly and daily based fuel consumption can be checked in the detailed menu as well.



### IPC (Intelligent Power Control)

The IPC controls power control depending on work environments. Its mode can be selected and released on the monitor. On the excavation mode, pump flow can be easily controlled by a lever, reducing fuel consumption.

### New Variable Power Control

The HX Series minimizes equipment input and output control signals to improve fuel efficiency. Its three-stage Power mode ensures the highest performance in any operating environment.

\* P (power) mode: Maximizes speed and power of the equipment for heavy load work.

\* S (standard) mode: Optimizes performance and fuel efficiency of the equipment for general load work.

\* E (economy) mode: Improves the control system for light load work.

### Enlarged Air Inlet with Grill Cover

Enlarged vent hole of the air inlet side cover and fine net grill to prevent penetration of foreign materials further improve durability.



### Attachment Flow Control (Option)

The HX Series improves pump flow rate by independent control of two pumps. It optimizes attachments for effective flow rate setting depending on attachments (ten breaker types and ten crusher types), enabling various operations matching the site environments.



### New Cooling System with Increased Air Flow

With the three-floor stacked cooling module improving air inflow, the HX Series provides excellent cooling performance by increasing heat dissipation and can be easily cleaned.

### Boom Floating Control (Option)

In order to achieve efficient leveling work by arm-in and arm-out operation with the boom fixed, the HX Series applies boom floating control, allowing stable operation even in high-load work.

# MORE RELIABLE, MORE SUSTAINABLE

## New Exterior Design for Robustness and Safety

The true value of the HX Series lies in its durability. The robust upper and lower frame structure that can endure external shock and high-load work and the attachments whose performance was proven by rigorous tests further show the real value of the HX Series in tough working environments and promise higher productivity.



### Durable Cooling Module

The HX Series has a durable cooling module that passed stringent tests, demonstrating the highest productivity in tough working environments.



### Reinforced Pin, Bush and Polymer Shim

The HX series improves lubricity of connecting parts between the equipment and attachments. Gaps with attachments are minimized by wear-resistant long-life pins, bushes and polymer shims, supporting the highest performance with invariable durability.

### Wear Resistant Cover Plate

A wear-resistant cover plate is installed at the end of the arm to minimize abrasion on the connector between the arm and the bucket. Reduction of vibration of the buckets enables more stable operation even in high-load work.



### Reinforced Durability of Upper and Lower Structure and Attachments

The upper and lower structure and attachments of the HX Series have higher durability than demanded on the site, as proven through numerous tests including road tests and virtual simulation. The wear resistance of the bucket has been improved by use of new material. Durability of Arm and Boom have been reinforced by 1.5 times, compared to the previous generation 9-series.





\*Photo may include optional equipment.

### **Hi-grade (High-pressure) Hoses**

The HX Series uses high-pressure hoses with improved heat and pressure resistance, greatly increasing the durability of the equipment.





### New Air Conditioning System

With further improved air conditioning and heating, the HX Series increases the APTC capacity by 15% to provide a pleasant environment for operators all the time. The ventilation was designed such that warm and cool air even reach operators' faces (increasing their work satisfaction) or allowing pleasant working environment.



# INFOTAINMENT FRONTIER

## Enhanced Instrument Panel for Easier Monitoring

Many electronic functions are concentrated on the most convenient spot for operators to ensure work efficiency. The highly-advanced infotainment system, a product of HHI's intensive information technology, enables both productivity and pleasant work at the same time! The HX Series of HHI provides higher value and pleasure to customers.



### Intelligent and Wide Cluster

The 8-inch capacitive-type display (like smartphone display) of the HX Series is 30% larger than the previous model, delivering excellent legibility. The centralized switches on the display allow convenience of checking the urea level and temperature outside the cabin. The audio AUX, air conditioner and heater interoperation, and inclination sensor also maximize operator's convenience.



### Haptic Control

The integrated jog shuttle-type haptic controller applies to the accelerator, remote air conditioner controller and operation of the cluster, allowing convenient operation. In the event of failure of the haptic switch, the emergency mode is activated on the cluster to ensure fail-safe function.

### Wi-Fi Direct with Smart Phone (Miracast)

The Miracast system based on Wi-Fi of the operator's smart phone enables easy and convenient use of various features of the smart phone on the big screen including navigation, web surfing, viewing of videos, and listening to music. (For Android mobile phone now)



### New Audio System

Radio player, USB-based MP3 player, integrated Bluetooth hands-free feature, and built-in microphone allow convenient phone calls while in work and in transit. The radio player was moved to the right side from the rear, allowing easier access.

### Proportional Auxiliary Hydraulic System

- Opt: Proportional control switch for better speed control
- Enlarge the operation convenience

# MODERN COMFORT, SIMPLE AND SAFE SOLUTION

## New Cabin for More Comfort

Low noise, low vibration, and ergonomic design make the cabin space more comfortable and pleasant! With focus on safety and convenience of operators, the HX Series allows rapid and safe equipment inspection anytime and anywhere, providing an optimal environment for operators to work.



### AAVM (Advanced Around View Monitoring) Camera System (Option)

The HX Series has a state-of-the-art AAVM video camera system to secure field of vision for operators in all directions, thereby preventing accidents. Operators can easily check the workplace in the front, rear and to the right and left.



\* AAVM (Advanced Around View Monitoring): Secure field of vision in all directions by nine views including 3D bird's eye view and 2D/4CH view.

\* IMOD (Intelligent Moving Object Detection): Inform when people or dangerous objects are detected within the range of operation (recognition distance: 5 m).



### Hi MATE (Remote Management System)

Hi MATE, Hyundai's proprietary remote management system, provides operators and dealer service personnel access to vital service and diagnostic information on the machine from any computer with internet access. Users can pinpoint machine location using digital mapping and set machine work boundaries, reducing the need for multiple service calls. Hi MATE saves time and money for the owner and dealer by promoting preventative maintenance and reducing machine downtime.

### Easy Access to DEF/AdBlue® Supply System

The DEF/AdBlue® tank is installed inside the tool box and its inlet is remotely located for easy access and convenient supply. Warning of overfill is given by a red lamp signal. The DEF/AdBlue® supply module is attached on the side of the fuel tank for easy maintenance and filter replacement.

\* Operation of the system may be affected by the condition of telecommunication signal





\*Photo may include optional equipment.

### **Cab Suspension Mount**

With a low-vibration design by the coil spring and damper inside the mount, the cab suspension mount of the HX Series reduces noise inside the cabin and improves durability, providing a comfortable operation space that lessens operators' fatigue.

# SPECIFICATIONS

ENGINE			
Maker / Model		Scania DC13 084A	
Type		4-cycle turbocharged, charge air cooled diesel engine	
Rated flywheel horse power	SAE	J1995 (gross)	331 kW (444 HP) at 1,900 rpm
		J1349 (net)	316 kW (424 HP) at 1,900 rpm
	DIN	6271/1 (gross)	331 kW (450 PS) at 1,900 rpm
		6271/1 (net)	316 kW (430 PS) at 1,900 rpm
Max. torque		232 kgf-m (1.678 lbf-ft) at 1,250 rpm	
Bore x stroke		130 x 160 mm (5.12" x 6.3")	
Piston displacement		12,700 cc (775 cu in)	
Batteries		24 V x 200 Ah	
Starting motor		24 V x 6 kW	
Alternator		24 V x 100 A	

HYDRAULIC SYSTEM	
MAIN PUMP	
Type	Variable displacement tandem axis piston pumps
Max. flow	2 x 380 l/min (100.4 U.S. gpm / 83.6 U.K. gpm)
Sub-pump for pilot circuit	Gear pump
Cross-sensing and fuel saving pump system	

HYDRAULIC MOTORS	
Travel	Two speed axial pistons motor with brake valve and parking brake
Swing	Axial piston motor with automatic brake

RELIEF VALVE SETTING	
Implement circuits	330 kgf/cm <sup>2</sup> (4,690 psi)
Travel	330 kgf/cm <sup>2</sup> (4,690 psi)
Power boost (boom, arm, bucket)	360 kgf/cm <sup>2</sup> (5,120 psi)
Swing circuit	285 kgf/cm <sup>2</sup> (4,050 psi)
Pilot circuit	40 kgf/cm <sup>2</sup> (569 psi)
Service valve	Installed

HYDRAULIC CYLINDERS	
No. of cylinder bore x stroke	Boom: Ø 170 x 1,570 mm
	Arm: Ø 190 x 1,820 mm
	Bucket: Ø 170 x 1,370 mm

DRIVES & BRAKES	
Drive method	Fully hydrostatic type
Drive motor	Axial piston motor, in-shoe design
Reduction system	Planetary reduction gear
Max. drawbar pull	34,100 kgf (75,180 lbf)
Max. travel speed (high / low)	5.3km/hr(3.29mph)/3.3km/hr(2.05mph)
Gradeability	35° (70%)
Parking brake	Multi wet disc

CONTROL	
Pilot pressure operated joysticks and pedals with detachable lever provide almost effortless and fatigueless operation.	
Pilot control	Two joysticks with one safety lever (LH): Swing and arm (RH): Boom and bucket (ISO)
Traveling and steering	Two levers with pedals
Engine throttle	Electric, Dial type

SWING SYSTEM	
Swing motor	Fixed displacement axial piston motor
Swing reduction	Planetary gear reduction
Swing bearing lubrication	Grease-bathed
Swing brake	Multi wet disc
Swing speed	8.6 rpm

SERVICE REFILL CAPACITIES			
Re-filling	liter	US gal	UK gal
Fuel tank	610	161.1	134.2
Engine coolant	50	13.2	11
Engine oil	39	10.3	8.6
Swing device	7	1.8	1.54
Final drive (each)	12	3.2	2.64
Hydraulic system (including tank)	486	128.4	105.9
Hydraulic tank	262	69.2	57.6
DEF/AdBlue®	69	18.2	15.2

UNDERCARRIAGE	
The X-leg type center frame is integrally welded with reinforced box-section track frames. The undercarriage includes lubricated rollers, idlers, track adjusters with shock absorbing springs and sprockets and a track chain with double or triple grouser shoes.	
Center frame	X - leg type
Track frame	Pentagonal box type
No. of shoes on each side	53 EA
No. of carrier roller on each side	3 EA
No. of track roller on each side	9 EA
No. of rail guard on each side	2 EA

OPERATING WEIGHT (APPROXIMATE)	
Operating weight, including 7,060 mm (23' 2") boom; 3,380 mm (11' 1") arm; SAE heaped 2,2 m <sup>3</sup> (2.88 yd <sup>3</sup> ) bucket, lubricant, coolant, full fuel tank, full hydraulic tank and all standard equipments.	

OPERATING WEIGHT				
Shoes		Operating weight		Ground pressure
Type	Width mm (in)	kg (lb)		kgf / cm <sup>2</sup> (psi)
Triple grouser	600 (24")	HX520 L	52,400 (115,520)	0.91 (12.94)
	700 (28")	HX520 L	52,920 (116,670)	0.79 (11.23)
	800 (32")	HX520 L	53,180 (117,240)	0.74 (10.52)
Double grouser	600 (24")	HX520 L	52,215 (115,110)	0.91 (12.94)
	700 (28")	HX520 L	52,735 (116,260)	0.78 (11.09)
Heavy duty grouser	600 (24")	HX520 HD	52,580 (115,920)	0.91 (12.94)
	700 (28")	HX520 HD	53,130 (117,130)	0.79 (11.2)



# BUCKET SELECTION GUIDE & DIGGING FORCE

## BUCKETS

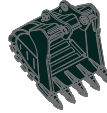
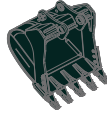
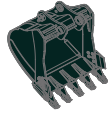

SAE heaped  
m<sup>3</sup> (yd<sup>3</sup>)

1.00 (1.31)  
1.38 (1.8)  
2.20 (2.88)  
2.79 (3.65)  
3.00 (3.92)

◆ 2.20 (2.88)  
◆ 2.43 (3.18)  
◆ 2.79 (3.65)  
◆ 3.20 (4.19)

◆ 2.20 (2.88)  
◆ 2.43 (3.18)  
◆ 2.79 (3.65)  
◆ 3.20 (4.19)

◆ 1.81 (2.37)

◆ 2.70 (3.53)  
◆ 3.00 (3.92)

Capacity m <sup>3</sup> (yd <sup>3</sup> )		Width mm (in)	Weight kg (lb)	Recommendation mm (ft.in)						
				6,550 (21' 6") Boom		7,060 (23' 2") Boom			9,000 (29' 6") Boom	
				2,400 (7' 10") Arm	2,900 (9' 6") Arm	2,400 (7' 10") Arm	2,900 (9' 6") Arm	3,380 (11' 1") Arm	4,000 (7' 10") Arm	6,000 (19' 8") Arm
1.00 (1.31)	0.90 (1.18)	1,030 (41")	1,450 (3,200)	●	●	●	●	●	●	●
1.38 (1.8)	1.24 (1.62)	1,215 (48")	1,670 (3,680)	●	●	●	●	●	●	○
2.20 (2.88)	1.93 (2.52)	1,685 (66")	2,030 (4,480)	●	●	●	●	●	●	-
2.79 (3.65)	2.47 (3.23)	1,865 (73")	2,300 (5,070)	●	●	●	⊙	⊙	⊙	-
3.00 (3.92)	2.70 (3.53)	1,985 (78")	2,440 (5,380)	●	●	⊙	⊙	⊙	○	-
◆ 2.20 (2.88)	1.93 (2.52)	1,685 (66")	2,320 (5,110)	●	●	●	●	●	●	-
◆ 2.43 (3.18)	2.11 (2.76)	1,830 (72")	2,450 (5,400)	●	●	●	●	●	⊙	-
◆ 2.79 (3.65)	2.47 (3.23)	1,865 (73")	2,630 (5,800)	●	●	●	⊙	⊙	○	-
◆ 3.20 (4.19)	2.82 (3.69)	2,075 (82")	2,870 (6,330)	⊙	⊙	⊙	○	○	○	-
◆ 1.81 (2.37)	1.50 (1.96)	1,540 (61")	2,650 (5,840)	●	●	●	●	●	-	-
◆ 2.20 (2.88)	1.93 (2.52)	1,685 (66")	2,610 (5,750)	●	●	●	●	●	-	-
◆ 2.43 (3.18)	2.11 (2.76)	1,830 (72")	2,730 (6,020)	●	●	●	●	⊙	-	-
◆ 2.79 (3.65)	2.47 (3.23)	1,865 (73")	2,950 (6,500)	●	⊙	⊙	⊙	⊙	-	-
◆ 3.20 (4.19)	2.82 (3.69)	2,075 (82")	3,230 (7,120)	⊙	⊙	○	○	○	-	-
◆ 2.70 (3.53)	2.39 (3.13)	1,800 (71")	2,770 (6,110)	●	●	●	⊙	⊙	-	-
◆ 3.00 (3.92)	2.76 (3.61)	1,995 (79")	3,040 (6,700)	⊙	⊙	⊙	○	○	-	-

- ◆ Heavy duty bucket
- ◆ Rock-Heavy duty bucket

- : Applicable for materials with density of 2,000 kg /m<sup>3</sup> (3,370 lb/ yd<sup>3</sup>) or less
- ⊙ : Applicable for materials with density of 1,600 kg /m<sup>3</sup> (2,700 lb/ yd<sup>3</sup>) or less
- : Applicable for materials with density of 1,100 kg /m<sup>3</sup> (1,850 lb/ yd<sup>3</sup>) or less

## ATTACHMENT

Booms and arms are welded with a low-stress, full-box section design.  
6.55 m (21' 6"); 7.06 m (23' 2") & 9.0 m (29' 6") Booms and 2.4 m (7' 10"); 2.9 m (9' 6"); 3.38 m (11' 1"); 4.0 m (7' 10") & 6.0 m (19' 8") Arms are available.

## DIGGING FORCE

Boom	Length	mm (ft.in)	6,550 (21' 6")		7,060 (23' 2")			9,000 (29' 6")	Remarks:	
	Weight	kg (lb)	4,340 (9,570)		4,370 (9,630)			5,130 (11,310)		
Arm	Length	mm (ft.in)	2,400 (7' 10")	2,900 (9' 6")	2,400 (7' 10")	2,900 (9' 6")	3,380 (11' 1")	4,000 (13' 1")	6,000 (19' 8")	
	Weight	kg (lb)	2,430 (5,360)	2,630 (5,800)	2,430 (5,360)	2,630 (5,800)	2,670 (5,890)	2,760 (6,080)	3,290 (7,250)	
Bucket digging force	SAE	kN	241.2 [263.2]	241.2 [263.2]	241.2 [263.2]	241.2 [263.2]	241.2 [263.2]	241.2 [263.2]	184.4	[ ]: Power Boost
		kgf	24600 [26840]	24600 [26840]	24600 [26840]	24600 [26840]	24600 [26840]	24600 [26840]	18800	
		lbf	54230 [59170]	54230 [59170]	54230 [59170]	54230 [59170]	54230 [59170]	54230 [59170]	41450	
	ISO	kN	280.5 [306.0]	280.5 [306.0]	280.5 [306.0]	280.5 [306.0]	280.5 [306.0]	280.5 [306.0]	213.8	
		kgf	28600 [31200]	28600 [31200]	28600 [31200]	28600 [31200]	28600 [31200]	28600 [31200]	21800	
		lbf	63050 [68780]	63050 [68780]	63050 [68780]	63050 [68780]	63050 [68780]	63050 [68780]	48060	
Arm crowd force	SAE	kN	278.5 [303.8]	225.6 [246.1]	278.5 [303.8]	225.6 [246.1]	192.2 [209.7]	171.6 [187.2]	103.0	
		kgf	28400 [30980]	23000 [25090]	28400 [30980]	23000 [25090]	19600 [21380]	17500 [19090]	10500	
		lbf	62610 [68300]	50710 [55310]	62610 [68300]	50710 [55310]	43210 [47130]	38580 [42090]	23150	
	ISO	kN	291.3 [317.7]	235.4 [256.7]	291.3 [317.7]	235.4 [256.7]	200.1 [218.2]	177.5 [193.7]	105.9	
		kgf	29700 [32400]	24000 [26180]	29700 [32400]	24000 [26180]	20400 [22250]	18100 [19750]	10800	
		lbf	65480 [71430]	52910 [57720]	65480 [71430]	52910 [57720]	44970 [49050]	39900 [43540]	23810	

Note : Boom weight includes arm cylinder, piping, and pin  
Arm weight includes bucket cylinder, linkage, and pin

# DIMENSIONS & WORKING RANGE

## HX520 L DIMENSIONS

6.55 m (21' 6"); 7.06 m (23' 2") & 9.0 m (29' 6") BOOM and 2.4 m (7' 10"); 2.9 m (9' 6"); 3.38 m (11' 1"); 4.09 m (13' 1") & 6.0 m (19' 8") ARM

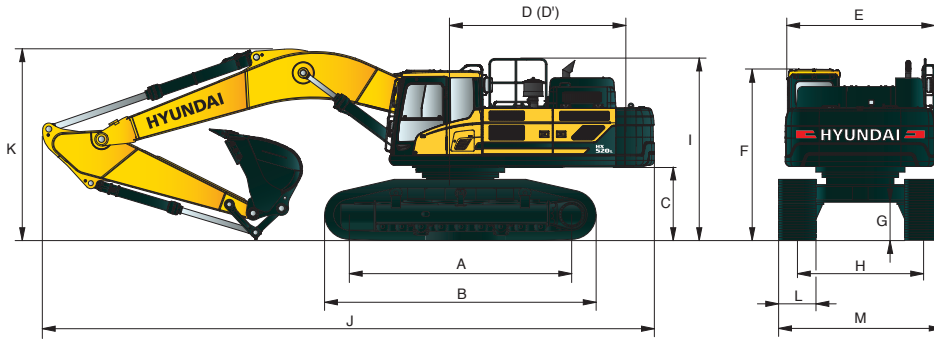

Unit : mm (ft-in)

A	Tumbler distance	4,470 (14' 8")
B	Overall length of crawler	5,460 (17' 11")
C	Ground clearance of counterweight	1,445 (4' 9")
D	Tail swing radius	3,940 (12' 11")
D'	Rear-end length	3,885 (12' 9")
E	Overall width of upperstructure	2,980 (9' 9")
F	Overall height of cab	3,340 (10' 11")
G	Min. ground clearance	770 (2' 6")
H	Track gauge Extended	2,940 (9' 8")
	Retracted	2,380 (7' 10")
I	Overall height of guardrail	3,595 (11' 8")

Boom length		6,550 (21' 6")	7,060 (23' 2")	9,000 (29' 6")				
	Arm length	2,400 (7' 10")	2,900 (9' 6")	2,400 (7' 10")	2,900 (9' 6")	3,380 (11' 1")	4,000 (13' 8")	6,000 (19' 8")
J Overall length		12,000 (39' 4")	11,870 (38' 11")	12,510 (41' 1")	12,380 (40' 7")	12,260 (40' 3")	12,250 (40' 2")	14,200 (46' 7")
	K Overall height of boom	4,190 (13' 9")	4,080 (13' 5")	4,070 (13' 4")	3,920 (12' 10")	3,790 (12' 5")	4,090 (13' 5")	3,960 (13' 0")
L Track shoe width		600 (24")	700 (28")	750 (30")	800 (32")			
	M Overall width	Extended	3,540 (11' 7")	3,640 (11' 11")	3,690 (12' 1")	3,740 (12' 3")		
Retracted		2,980 (9' 10")	3,080 (10' 1")	3,130 (10' 3")	3,180 (10' 5")			

## HX520 L WORKING RANGE

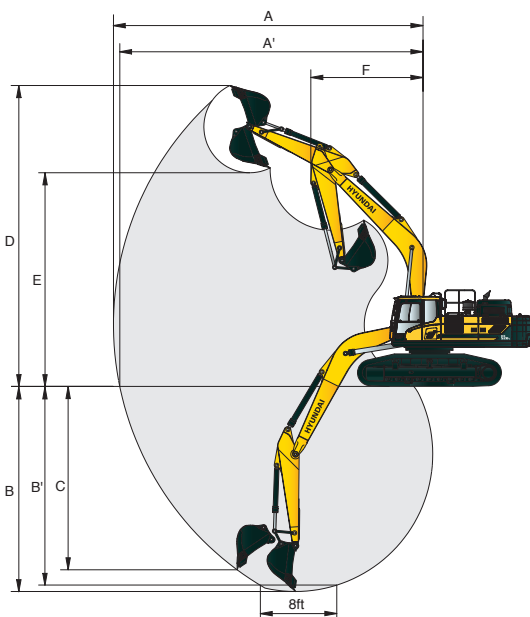

Unit : mm (ft-in)

Boom length		6,550 (21' 6")	7,060 (23' 2")	9,000 (29' 6")				
	Arm length	2,400 (7' 10")	2,900 (9' 6")	2,400 (7' 10")	2,900 (9' 6")	3,380 (11' 1")	4,000 (13' 1")	6,000 (19' 8")
A Max. digging reach		10,690 (35' 1")	11,130 (36' 6")	11,200 (36' 9")	11,620 (38' 1")	12,040 (39' 6")	12,600 (41' 4")	16,180 (53' 1")
	A' Max. digging reach on ground	10,430 (34' 3")	10,870 (35' 8")	10,950 (35' 11")	11,380 (37' 4")	11,810 (38' 9")	12,380 (40' 7")	16,010 (52' 6")
B Max. digging depth		6,240 (20' 6")	6,740 (22' 1")	6,630 (21' 9")	7,130 (23' 5")	7,610 (25' 0")	8,230 (27' 0")	11,870 (38' 11")
	B' Max. digging depth (8' level)	6,060 (19' 11")	6,580 (21' 7")	6,460 (21' 2")	6,980 (22' 11")	7,470 (24' 6")	8,110 (26' 7")	11,770 (38' 7")
C	Max. vertical wall digging depth	4,370 (14' 4")	5,420 (17' 9")	4,650 (15' 3")	5,660 (18' 7")	5,770 (18' 11")	6,320 (20' 9")	8,360 (27' 5")
D	Max. digging height	10,390 (34' 1")	10,660 (35' 0")	10,750 (35' 3")	10,980 (36' 0")	11,060 (36' 3")	11,280 (37' 0")	12,590 (41' 4")
E	Max. dumping height	7,040 (23' 1")	7,210 (23' 8")	7,410 (24' 4")	7,540 (24' 9")	7,690 (25' 3")	7,910 (25' 11")	9,410 (30' 10")
F	Min. front swing radius	4,870 (16' 0")	4,540 (14' 11")	5,160 (16' 11")	4,890 (16' 1")	4,850 (15' 11")	4,710 (15' 5")	6,140 (20' 2")













# LIFTING CAPACITY











 Rating over-front  Rating over-side or 360 degrees

## HX520 L

6.55 m (21' 6") boom; 2.40 m (7' 10") arm equipped with 3.03 m<sup>3</sup> (SAE heaped) bucket and 600 mm (24") triple grouser shoes.

Load point height m (ft)	Load radius								At max. reach			
	3.0 m (10 ft)		4.5 m (15 ft)		6.0 m (20 ft)		7.5 m (25 ft)		Capacity		Reach m (ft)	
												
6.0 m (20 ft)	kg					*13290	*13290	*12630	11600	*11270	7540	9.8
	lb					*29290	*29290	*27840	25560	*24840	16610	32.02
4.5 m (15 ft)	kg		*19010	*19010	*15250	*15250	*13520	11190		10630	6840	10.22
	lb		*41910	*41910	*33630	*33630	*29820	24660		23430	15070	33.39
3.0 m (10 ft)	kg				*17320	15170	*14580	10730		10240	6540	10.36
	lb				*38170	33450	*32140	23650		22560	14410	33.86
1.5 m (5 ft)	kg				*18760	14520	*15410	10350		10320	6560	10.25
	lb				*41370	32000	*333970	22810		22740	14460	33.48
Ground Line	kg		*24850	22470	*19270	14170	*15740	10110		10920	6943	9.86
	lb		*54790	49530	*42470	31240	*34690	22290		24080	15310	32.22
-1.5 m (-5 ft)	kg	*26490	*26490	*23670	22520	*18780	14100	*15300	10070	*11680	7850	9.17
	lb	*58390	*58390	*52180	49650	*41440	31090	*33740	22210	*25740	17300	29.95
-3.0 m (-10 ft)	kg	*26910	*26910	*21450	*21450	*17220	14290			*11150	9790	8.05
	lb	*59330	*59330	*47290	*47290	*37970	31510			*24580	21590	26.31
-4.5 m (-15 ft)	kg			*17540	*17540					*10720	*10720	7.49
	lb			*38660	*38660					*23640	*23640	24.46

6.55 m (21' 6") boom; 2.90 m (9' 6") arm equipped with 3.03 m<sup>3</sup> (SAE heaped) bucket and 600 mm (24") triple grouser shoes.

Load point height m (ft)	Load radius								At max. reach				
	3.0 m (10 ft)		4.5 m (15 ft)		6.0 m (20 ft)		7.5 m (25 ft)		9.0 m (30 ft)		Capacity		Reach m (ft)
													
7.5 m (25 ft)	kg						*11640	*11640			*8710	8100	9.54
	lb						*25650	*25650			*19200	17850	31.17
6.0 m (20 ft)	kg						*12110	11690			*8690	6970	10.24
	lb						*26700	25770			*19170	15360	33.44
4.5 m (15 ft)	kg		*17530	*17530	*14570	*14570	*13130	11250			*8810	6340	10.63
	lb		*38640	*38640	*32110	*32110	*28940	24800			*19410	13990	34.73
3.0 m (10 ft)	kg		*22060	*22060	*16800	15320	*14310	10750	12550	7950	*9040	6060	10.77
	lb		*48640	*48640	*37040	33770	*31550	23710	27660	17530	*19930	13370	35.18
1.5 m (5 ft)	kg		*24760	22820	*18540	14560	*15320	10320	12290	7720	*9420	6070	10.66
	lb		*51590	50310	*40880	32100	*33770	22750	27100	17010	*20770	13380	34.82
Ground Line	kg		*25340	22320	*19390	14110	*15870	10020			*9990	6380	10.29
	lb		*55860	49210	*42740	31100	*34980	22090			*22230	14070	33.62
-1.5 m (-5 ft)	kg	*24530	*24530	*24590	22260	*19270	13950	*15750	9910		*10880	7120	9.63
	lb	*54080	*54080	*54220	49070	*42480	30750	*34720	21840		*23960	15700	31.47
-3.0 m (-10 ft)	kg	*29690	*29690	*22760	22480	*18120	14040	*14610	10020		*11430	8670	8.59
	lb	*65460	*65460	*50180	49560	*39940	30960	*32200	22100		*25200	19120	28.07
-4.5 m (-15 ft)	kg			*19480	*19490	*15400	14460				*10840	*10840	7.5
	lb			*42950	*42950	*33860	31880				*23900	*23900	24.5



1. Lifting capacity are based on SAE J1097 and ISO 10567.

2. Lifting capacity of the HX series does not exceed 75% of tipping load with the machine on firm, level ground or 87% of full hydraulic capacity.

3. The load point is a hook located on the back of the bucket.













4. (\*) indicates load limited by hydraulic capacity.

# LIFTING CAPACITY













 Rating over-front  Rating over-side or 360 degrees

## HX520 L













7.06 m (23' 2") boom; 2.40 m (7' 10") arm equipped with 3.03 m<sup>3</sup> (SAE heaped) bucket and 600 mm (24") triple grouser shoes.

Load point height m (ft)	Load radius										At max. reach		
	3.0 m (10 ft)		4.5 m (15 ft)		6.0 m (20 ft)		7.5 m (25 ft)		9.0 m (30 ft)		Capacity	Reach	
													m (ft)
7.5 m (25 ft)	kg						*11960	11760			*10860	7810	9.66
	lb						*26360	25920			*23940	17210	31.56
6.0 m (20 ft)	kg				*13590	*13590	*12590	11430			10460	6730	10.35
	lb				*29970	*29970	*27750	25200			23050	14840	33.8
4.5 m (15 ft)	kg				*15800	15620	*13470	10950	*12580	8060	9650	6150	10.74
	lb				*34820	34430	*30150	24130	*27740	17770	21280	13550	35.07
3.0 m (10 ft)	kg				*17920	14690	*14820	10450	12380	7810	9320	5880	10.87
	lb				*38510	32390	*32680	23030	27290	17210	20540	12970	35.52
1.5 m (5 ft)	kg				*19270	14070	*15690	10050	12140	7590	9380	5900	10.76
	lb				*42480	31010	*34590	22150	26760	16730	20670	13000	35.16
Ground Line	kg				*19640	13780	15940	9820			9870	6210	10.4
	lb				*43300	30370	35140	21640			21760	13700	33.97
-1.5 m (-5 ft)	kg		*23730	22120	*19170	13740	*15770	9760			10980	6740	9.75
	lb		*52320	48760	*42270	30290	*34760	21530			24210	15300	31.85
-3.0 m (-10 ft)	kg	*26500	*26500	*21830	*21830	*17840	13910	*14540	9930		*11140	8420	8.74
	lb	*58420	*58420	*48130	*48130	*39330	30680	*32060	21900		*24560	18560	28.54
-4.5 m (-15 ft)	kg		*18680	*18680	*15140	14380					*10560	10260	7.8
	lb		*41180	*41180	*33380	31710					*23280	22620	25.47

7.06 m (23' 2") boom; 2.90 m (9' 6") arm equipped with 3.03 m<sup>3</sup> (SAE heaped) bucket and 600 mm (24") triple grouser shoes.

Load point height m (ft)	Load radius										At max. reach		
	3.0 m (10 ft)		4.5 m (15 ft)		6.0 m (20 ft)		7.5 m (25 ft)		9.0 m (30 ft)		Capacity	Reach	
													m (ft)
7.5 m (25 ft)	kg						*11360	*11360			*9210	7190	10.11
	lb						*25050	*25050			*20310	15860	33.03
6.0 m (20 ft)	kg						*12120	11520			*9220	6250	10.76
	lb						*26730	25400			*20340	13770	35.15
4.5 m (15 ft)	kg		*19010	*19010	*15110	*15110	*13300	11010	*12330	8060	9050	5720	11.13
	lb		*41900	*41900	*33310	*33310	*29320	24270	*27180	17770	19940	12600	36.37
3.0 m (10 ft)	kg		*23620	23090	*17420	14840	*14570	10470	12350	7770	8730	5470	11.26
	lb		*52060	50900	*38400	32710	*32120	23090	27230	17130	19250	12600	36.8
1.5 m (5 ft)	kg		*21570	*21570	*19080	14200	*15610	10020	12070	7510	8770	5460	11.16
	lb		*47560	*47560	*42070	31080	*34410	22090	26600	16560	19320	12040	36.45
Ground Line	kg		*25090	21760	*19800	13690	15860	9730	11880	7340	9180	5720	10.81
	lb		*55310	47970	*43660	30190	34960	21440	26180	16170	20230	12610	35.32
-1.5 m (-5 ft)	kg	*20350	*20350	*24810	21780	*19640	13570	15730	9610		10110	6330	10.19
	lb	*44860	*44560	*54690	48020	*43300	29910	34670	21180		22280	13950	33.3
-3.0 m (-10 ft)	kg	*28610	*28610	*23130	22020	*18630	13670	*15310	9690		*11360	7540	9.23
	lb	*63060	*63060	*50990	48550	*41080	30140	*33750	21360		*25040	16620	30.17
-4.5 m (-15 ft)	kg		*20370	*20370	*16510	14020					*10730	10170	7.79
	lb		*44710	*44910	*36390	30910					*23650	22430	25.43

7.06 m (23' 2") boom; 3.38 m (11' 1") arm equipped with 3.03 m<sup>3</sup> (SAE heaped) bucket and 600 mm (24") triple grouser shoes.

Load point height m (ft)	Load radius										At max. reach			
	3.0 m (10 ft)		4.5 m (15 ft)		6.0 m (20 ft)		7.5 m (25 ft)		9.0 m (30 ft)		Capacity	Reach		
													m (ft)	
6.0 m (20 ft)	kg						*11640	*11640	*11410	8380	*7750	5820	11.18	
	lb						*25650	*25650	*25160	18480	*17080	12840	36.53	
4.5 m (15 ft)	kg		*17410	*17410	*14350	*14350	*12860	11130	*12030	8110	*7860	5340	11.54	
	lb		*38390	*38390	*31640	*31640	*28360	24540	*26530	17890	*17330	11780	37.7	
3.0 m (10 ft)	kg		*22210	*22210	*16770	15090	*14210	10580	12390	7800	*8060	5120	11.67	
	lb		*48960	*48960	*36960	33280	*31330	23320	27320	17200	*17760	11280	38.11	
1.5 m (5 ft)	kg		*25070	22400	*18660	14280	*15370	10100	12080	7520	8240	5100	11.57	
	lb		*55270	49380	*41150	31490	*33880	22260	26630	16570	18160	11250	37.78	
Ground Line	kg		*25800	21880	*19670	13790	15990	9760	11848	7310	8580	5320	11.23	
	lb		*56880	48230	*43370	30400	35040	21510	26120	16110	18930	11730	36.69	
-1.5 m (-5 ft)	kg	*19680	*19680	*25300	21780	*19800	13580	15700	9580	11750	7210	9370	5830	10.64
	lb	*43390	*43390	*55780	48010	*43640	29940	34620	21130	25890	15900	20660	12860	34.77
-3.0 m (-10 ft)	kg	*25950	*25950	*23920	21930	*19080	13600	15710	9590		*10510	6840	9.74	
	lb	*57200	*57200	*52700	48450	*42070	29990	346230	21140		*23180	15080	31.82	
-4.5 m (-15 ft)	kg	*27870	*27870	*21540	*21540	*17390	13850				*10990	8910	8.39	
	lb	*61430	*61430	*47480	*47480	*38330	30530				*24230	19640	27.41	

1. Lifting capacity are based on SAE J1097 and ISO 10567.

2. Lifting capacity of the HX series does not exceed 75% of tipping load with the machine on firm, level ground or 87% of full hydraulic capacity.

3. The load point is a hook located on the back of the bucket.

4. (\*) indicates load limited by hydraulic capacity.



















# LIFTING CAPACITY















 Rating over-front  Rating over-side or 360 degrees

## HX520 L

7.06 m (23' 2") boom; 4.0 m (13' 1") arm equipped with 3.03 m<sup>3</sup> (SAE heaped) bucket and 600 mm (24") triple grouser shoes.

Load point height m (ft)	Load radius										At max. reach							
	1.5 m (5 ft)		3.0 m (10 ft)		4.5 m (15 ft)		6.0 m (20 ft)		7.5 m (25 ft)		9.0 m (30 ft)		10.5 m (35 ft)		Capacity	Reach		
																	m (ft)	
7.5 m (25 ft)	kg											*10410	8730			*7170	6000	11.19
	lb											*22950	19250			*15800	13240	36.54
6.0 m (20 ft)	kg											*10810	8540			*7190	5300	11.77
	lb											*23840	18830			*15850	11680	38.45
4.5 m (15 ft)	kg											*12150	11350	*11540	8240	*9510	6140	12.11
	lb											*26790	25030	*25430	18170	*20960	13550	39.55
3.0 m (10 ft)	kg			*20300	*20300	*15800	15460	*13620	10760	*12390	7900	9570	5960	*7450	4680	*7450	4680	12.23
	lb			*44750	*44750	*34820	34070	*30040	23730	*27310	17410	21110	13140	*16430	10310	*16430	10310	39.94
1.5 m (5 ft)	kg			*24060	22850	*18020	14520	*14970	10220	12150	7570	9380	5780	7590	4650	7590	4650	12.13
	lb			*53050	50390	*39730	32020	*33000	22530	26780	16690	20670	12730	16720	10260	16720	10260	39.63
Ground Line	kg		*14190	*14190	*25720	21980	*19430	13890	*15930	9805	11860	7310	9230	5640	7860	4820	7860	11.82
	lb		*31290	*31290	*56710	48450	*42840	30620	*35120	21620	26150	16120	20340	12430	17340	10630	17340	38.6
-1.5 m (-5 ft)	kg	*14900	*14900	*18380	*18380	*25860	21670	*19950	13560	15680	9560	11690	7160		8490	5240	8490	11.26
	lb	*32850	*32850	*40520	*40520	*57000	47780	*43950	29900	34570	21070	25770	15770		18730	11550	18730	36.78
-3.0 m (-10 ft)	kg	*19020	*19020	*23290	*23290	*24940	21700	*19620	13480	15600	9480	16670	7140		7460	6020	7460	10.42
	lb	*41940	*41940	*51340	*51340	*54990	47830	*43250	29720	34390	20910	25720	15730		20850	13280	20850	34.05
-4.5 m (-15 ft)	kg			*29320	*29320	*23030	21980	*18390	13630	*15130	9600				10910	7550	10910	9.2
	lb			*64640	*64640	*50750	48470	*40550	30040	*33350	21160				24050	16650	24050	30.05
-6.0 m (-20 ft)	kg					*19800	*19800	*15870	14040						10660	9810	10660	7.93
	lb					*43650	*43650	*35000	30950						23500	21620	23500	25.91

9.0 m (29' 6") boom; 6.0 m (19' 8") arm equipped with 3.03 m<sup>3</sup> (SAE heaped) bucket and 600 mm (24") triple grouser shoes.

Load point height m (ft)	Load radius										At max. reach							
	3.0m (9.8ft)		5.0m (16.3ft)		7.0m (22.9ft)		9.0m (29.4ft)		11.0m (35.9ft)		13.0m (42.5ft)		Capacity	Reach				
															m (ft)			
8.0 m (26 ft)	kg											*6240	4340			*5120	3370	14.83
	lb											*13760	9560			*11280	7430	48.46
6.0 m (20 ft)	kg											*9373	6090			5060	2900	15.44
	lb											*20670	13410			11160	6390	50.43
4.0 m (13 ft)	kg											*11050	8260			4720	2620	15.74
	lb											*24370	18200			10410	5770	51.4
2.0 m (7 ft)	kg			*21520	18830	*15430	11260	12150	7480	8930	5200	6370	3670		4580	2490	4580	15.75
	lb			*47440	41510	*34020	24830	26790	16490	19030	11470	14040	8090		10100	5480	10100	51.44
Ground Line	kg	*9910	*9910	*18740	16960	17170	10170	11440	6830	8206	4800	6120	3430		4640	2500	4640	15.47
	lb	*21840	*21840	*41310	37400	37850	22420	25210	15060	18090	10590	13490	7570		10220	5510	10220	50.54
-2.0 m (-7 ft)	kg	*12430	*12430	*18870	16250	16450	9540	10950	6390	7990	4520	5950	3270		4910	2670	4910	14.9
	lb	*27400	*27400	*41310	35830	36270	21030	24140	14090	17410	9960	13110	7210		10830	5880	10830	48.66
-4.0 m (-13 ft)	kg	*15220	*15220	*21280	16130	16170	9290	10710	6170	7740	4370				5500	3060	5500	13.97
	lb	*33560	*33560	*46910	35570	35650	20480	23620	13610	17070	9640				12120	6740	12120	45.64
-6.0 m (-20 ft)	kg	*18350	*18350	*24410	16380	16220	9340	10710	6180	7780	4410				6630	3820	6630	12.62
	lb	*40460	*40460	*53810	36110	35760	20580	23620	13610	17150	9720				14620	8420	14620	41.22
-8.0 m (-26 ft)	kg	*21930	*21930	*21960	16950	16590	9660	10990	6430						9060	5450	9060	10.63
	lb	*48340	*48340	*48410	37370	36570	21290	24230	14170						19970	12020	19970	34.72
-10.0 m (-33 ft)	kg			*17820	*17820	*13830	10380								*10570	7950	*10570	8.72
	lb			*39280	*39280	*30490	22880								*23290	17520	*23290	28.48

1. Lifting capacity are based on SAE J1097 and ISO 10567.

2. Lifting capacity of the HX series does not exceed 75% of tipping load with the machine on firm, level ground or 87% of full hydraulic capacity.

3. The load point is a hook located on the back of the bucket.

4. (\*) indicates load limited by hydraulic capacity.

ENGINE	STD	OPT
Scania DC13 084A engine	●	
<b>HYDRAULIC SYSTEM</b>		
<b>Intelligent Power Control (IPC)</b>		
3-power mode, 2-work mode, user mode	●	
Variable Power Control	●	
Pump Flow Control	●	
Attachment Mode Flow Control		●
Engine Auto Idle	●	
Engine Auto Shutdown Control		●
<b>CABIN &amp; INTERIOR</b>		
<b>ISO Standard cabin</b>		
Rise-up type windshield wiper	●	
Radio / USB player	●	
Handsfree mobile phone system with USB	●	
12 volt power outlet (24V DC to 12V DC converter)	●	
Electric horn	●	
All-weather steel cab with 360° visibility	●	
Safety glass windows	●	
Sliding fold-in front window	●	
Sliding side window (LH)	●	
Lockable door	●	
Hot & cool box	●	
Storage compartment & Ashtray	●	
Transparent cabin roof-cover	●	
Sun visor	●	
Door and cab locks, one key	●	
Mechanical suspension seat with heater	●	
Pilot-operated slidable joystick	●	
Console box height adjust system	●	
<b>Automatic climate control</b>		
Air conditioner & heater	●	
Defroster	●	
Starting Aid (air grid heater) for cold weather	●	
<b>Centralized monitoring</b>		
8" LCD display	●	
Engine speed or Trip meter/Accel.	●	
Engine coolant temperature gauge	●	
Max power	●	
Low speed/High speed	●	
Auto idle	●	
Overload	●	
Check Engine	●	
Air cleaner clogging	●	
Indicators	●	
ECO Gauges	●	
Fuel level gauge	●	
Hyd. oil temperature gauge	●	
Fuel warmer	●	
Warnings	●	
Communication error	●	
Low battery	●	
Clock	●	
Cabin lights	●	
Cabin front window rain guard	●	
Cabin roof-steel cover		●
<b>Seat</b>		
Adjustable air suspension seat with heater		●
<b>Cabin FOPS/FOG (ISO/DIS 10262) Level 2</b>		
FOPS (Falling Object Protective Structure) · ISO 3449 Level 2	●	
FOG (Falling Object Guard)		●

SAFETY	STD	OPT
Battery master switch	●	
Rearview camera	●	
AAVM (Advanced Around View Monitoring)		●
Four front working lights	●	
Travel alarm	●	
Rear work lamp	●	
Beacon lamp		●
Automatic swing brake	●	
Boom holding system	●	
Arm holding system	●	
Safety lock valve for boom cylinder with overload warning device	●	
Safety lock valve for arm cylinder		●
Three outside rearview mirrors	●	
<b>OTHER</b>		
<b>Booms</b>		
6.55 m; 21' 6"		●
7.06 m; 23' 2"	●	
9.00 m; 29' 6"		●
<b>Arms</b>		
2.4 m; 7' 10"		●
2.9 m; 9' 6"		●
3.38 m; 11' 1"	●	
4.0 m; 13' 1"		●
6.0 m; 19' 8"		●
Removable clean-out dust net for cooler	●	
Removable reservoir tank	●	
Fuel pre-filter with fuel warmer	●	
Rain cap	●	
Pre-cleaner		●
Self-diagnostics system	●	
Hi MATE (Remote Management System)	●	
Batteries (2 x 12 V x 200 Ah)	●	
Fuel filler pump (50 l/min)		●
Single-acting piping kit (breaker, etc.)		●
Double-acting piping kit (clamshell, etc.)	●	
Rotating Piping Kit		●
Quick coupler piping		●
Quick coupler		●
Boom floating control		●
Accumulator for lowering work equipment	●	
Pattern change valve (2 patterns)		●
Tool kit		●
<b>UNDERCARRIAGE</b>		
Lower frame under cover (Additional)		●
Lower frame under cover (Normal)	●	
<b>Track shoes</b>		
Triple grouser shoes (600 mm; 24")	●	
Triple grouser shoes (700 mm; 28")		●
Triple grouser shoes (750 mm; 30")		●
Triple grouser shoes (800 mm; 32")		●
Double grouser shoes (600 mm; 24")		●
Double grouser shoes (700 mm; 28")		●
Heavy duty grouser shoes (600 mm; 24")		●
Heavy duty grouser shoes (700 mm; 28")		●
Track rail guard	●	
Full track rail guard high walker		●

STD = Standard  
OPT = Optional

- \* Standard and optional equipment may vary. Contact your Hyundai dealer for more information. The machine may vary according to International standards.
- \* The photos may include attachments and optional equipment that are not available in your area.
- \* Materials and specifications are subject to change without advance notice.
- \* All imperial measurements rounded off to the nearest pound or inch.
- \* The air conditioning system on this machine contains the fluorinated greenhouse gas refrigerant HFC-134a (Global Warming Potential = 1430). The system contains 0.8 kg of refrigerant which has a CO<sub>2</sub> equivalent of 1.144 metric tonne.



PLEASE CONTACT

Hyundai Construction Equipment Europe nv

Hyundailaan 4, 3980 Tessenderlo, Belgium Tel: (32) 14-56-2200 Fax: (32) 14-59-3405 www.hyundai.eu

EN - 2017.11 Rev 3